

DREAMING

ETERNA BELLEZZA
eternal beauty



LEA
CERAMICHE



**ETERNA
BELLEZZA**

Eternal
Beauty



**DREAMING
CALACATTA SHINE**

Pavimento / Floor
lux rett. 73x73cm / 29"x29"

**DREAMING
GRAY STONE**

Pavimento / Floor
lux rett. 73x73cm / 29"x29"





DREAMING ROMANCE SAFARI

Pavimento / Floor
velvet rett. 75x75cm / 30"x30"

Le venature del marmo giocano con lo spazio, lo muovono creando dinamismi dirompenti. In Dreaming la lucentezza dei materiali e la dimensione dei formati danno vita a spazi importanti, evocano un equilibrio classico e fresco allo stesso tempo, celebrano l'armonia e la bellezza.

The grain of the marble plays with space, the movement creates disruptive dynamics. With Dreaming the shininess of the material and the size of the formats enrich important spaces, evoke a classic and fresh balance at the same time, celebrate harmony and beauty.

DREAMING BIANCO STATUARIO

Pavimento / Floor
lux rett. 73x73cm / 29"x29"

La versione lux fa vibrare la luce creando spettacolari riflessi luminosi.

Dreaming: una collezione per rivivere il classico in una chiave del tutto contemporanea, per un arredamento sublime e senza tempo.

The lux version makes the light vibrate creating spectacular luminous reflections.

Dreaming: a collection to revive the classical period in a contemporary key, for sublime and timeless interiors.







**DREAMING
BIANCO STATUARIO**

Pavimento / Floor
lux rett. 73x73cm / 29"x29"



**DREAMING
PASSION PULPIS**

Pavimento / Floor
lux rett. 73x73cm / 29"x29"



**DREAMING
CALACATTA SHINE**

Pavimento / Floor
lux rett. 73x73cm / 29"x29"

DREAMING
GRAY STONE

Pavimento / Floor
lux rett. 73x73cm / 29"x29"



HOME IS
WHEREVER
I AM WITH
YOU





**DREAMING
CRYSTAL WHITE**

Pavimento / Floor
lux rett. 60x60cm / 24"x24"



CALACATTA SHINE



30x60cm / 12"x24"
lux rett. (spessore 10mm) LGVETX6
velvet rett. (spessore 10mm) LGVETR6



60x60cm / 24"x24"
lux rett. (spessore 10mm) LGWETV6
velvet rett. (spessore 10mm) LGWETR6



73x73cm / 29"x29"
lux rett. (spessore 11mm) LGOET65



75x75cm / 30"x30"
velvet rett. (spessore 11mm) LGOETR6

GRAY STONE

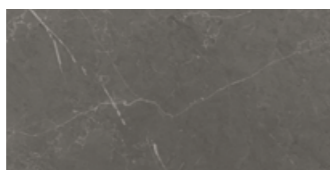

30x60cm / 12"x24"
lux rett. (spessore 10mm) LGVETX7
velvet rett. (spessore 10mm) LGVETR7



60x60cm / 24"x24"
lux rett. (spessore 10mm) LGWETV7
velvet rett. (spessore 10mm) LGWETR7



73x73cm / 29"x29"
lux rett. (spessore 11mm) LGOET75



75x75cm / 30"x30"
velvet rett. (spessore 11mm) LGOETR7

BIANCO STATUARIO

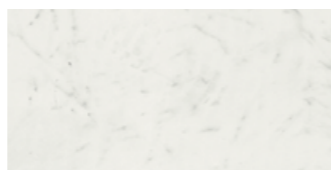

30x60cm / 12"x24"
lux rett. (spessore 10mm) LGVETL4
velvet rett. (spessore 10mm) LGVETR4



60x60cm / 24"x24"
lux rett. (spessore 10mm) LGWETL4
velvet rett. (spessore 10mm) LGWETR4



73x73cm / 29"x29"
lux rett. (spessore 11mm) LGOET45



75x75cm / 30"x30"
velvet rett. (spessore 11mm) LGOETR4

ROMANCE SAFARI

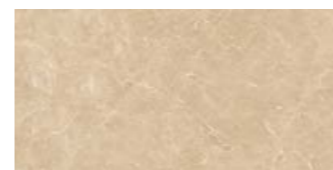

30x60cm / 12"x24"
lux rett. (spessore 10mm) LGVETX1
velvet rett. (spessore 10mm) LGVETR1



60x60cm / 24"x24"
lux rett. (spessore 10mm) LGWETV1
velvet rett. (spessore 10mm) LGWETR1



73x73cm / 29"x29"
lux rett. (spessore 11mm) LGOET15



75x75cm / 30"x30"
velvet rett. (spessore 11mm) LGOETR1

CRYSTAL WHITE

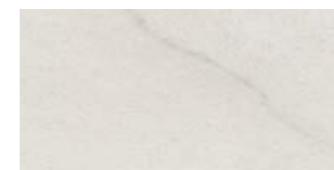

30x60cm / 12"x24"
lux rett. (spessore 10mm) LGVETX0
velvet rett. (spessore 10mm) LGVETR0

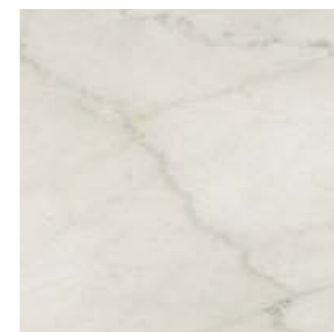

60x60cm / 24"x24"
lux rett. (spessore 10mm) LGWETV0
velvet rett. (spessore 10mm) LGWETR0

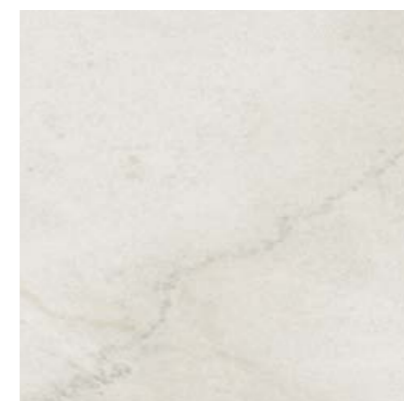

73x73cm / 29"x29"
lux rett. (spessore 11mm) LGOET05

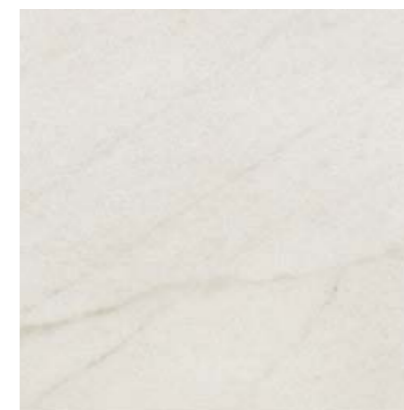

75x75cm / 30"x30"
velvet rett. (spessore 11mm) LGOETR0

PASSION PULPIS



30x60cm / 12"x24"
lux rett. (spessore 10mm) LGVETX2
velvet rett. (spessore 10mm) LGVETR2



60x60cm / 24"x24"
lux rett. (spessore 10mm) LGWETV2
velvet rett. (spessore 10mm) LGWETR2



73x73cm / 29"x29"
lux rett. (spessore 11mm) LGOET25



75x75cm / 30"x30"
velvet rett. (spessore 11mm) LGOETR2



MOSAICO BASIC
30x30cm / 12"x12"
calacatta shine lux
LG9ETM7

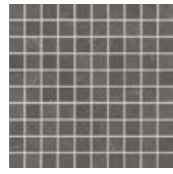

MOSAICO BASIC
30x30cm / 12"x12"
gray stone lux
LG9ETM8



DECORO SCRAPS BIANCO
60x60cm / 24"x24" LGWETS4



MOSAICO BASIC
30x30cm / 12"x12"
romance safari lux
LG9ETM1



MOSAICO BASIC
30x30cm / 12"x12"
bianco statuario lux
LG9ETM4



DECORO SCRAPS GRAY
60x60cm / 24"x24" LGWETS8

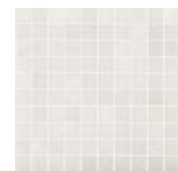

MOSAICO BASIC
30x30cm / 12"x12"
crystal white lux
LG9ETM0

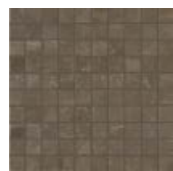

MOSAICO BASIC
30x30cm / 12"x12"
passion pulpis lux
LG9ETM2

LUX

VELVET

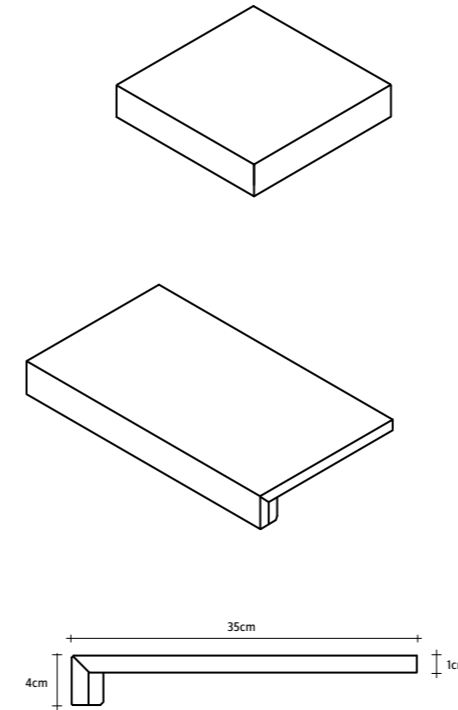

ANGOLO SX / DX GRADINO PLUS lux*
35x35cm / 13^{3/4}"x13^{3/4}"
bianco statuario LG9ETD4
crystal white LG9ETD0
romance safari LG9ETD1
passion pulpis LG9ETD2
calacatta shine LG9ETD3
gray stone LG9ET70

ANGOLO SX / DX GRADINO PLUS velvet*
35x35cm / 13^{3/4}"x13^{3/4}"
bianco statuario LG9ETD9
crystal white LG9ETD5
romance safari LG9ETD6
passion pulpis LG9ETD7
calacatta shine LG9ETD8
gray stone LG9ET71

GRADINO PLUS lux*
35x60cm / 13^{3/4}"x24"

bianco statuario LG9ETG4
crystal white LG9ETG0
romance safari LG9ETG1
passion pulpis LG9ETG2
calacatta shine LG9ETG3
gray stone LG9ET80

GRADINO PLUS velvet*
35x60cm / 13^{3/4}"x24"

bianco statuario LG9ETG9
crystal white LG9ETG5
romance safari LG9ETG6
passion pulpis LG9ETG7
calacatta shine LG9ETG8
gray stone LG9ET81

BATTISCOPA lux
10x60cm / 4"x24"

bianco statuario LGBETX4
crystal white LGBETX0
romance safari LGBETX1
passion pulpis LGBETX2
calacatta shine LGBETX7
gray stone LGBETX8

BATTISCOPA velvet
10x60cm / 4"x24"

bianco statuario LGBETR4
crystal white LGBETR0
romance safari LGBETR1
passion pulpis LGBETR2
calacatta shine LGBETR7
gray stone LGBETR8

RACCORDO JOLLY lux
1,3x30cm / 1/2"x12"

bianco statuario LG9ETJ4
crystal white LG9ETJ0
romance safari LG9ETJ1
passion pulpis LG9ETJ2
calacatta shine LG9ETJ7
gray stone LG9ET85

RACCORDO JOLLY velvet
1,3x30cm / 1/2"x12"

bianco statuario LG9ETJ9
crystal white LG9ETJ5
romance safari LG9ETJ6
passion pulpis LG9ETJ3
calacatta shine LG9ETJ8
gray stone LG9ET86

BEAK JOLLY lux
1,3x2cm / 1/2"x3/4"

bianco statuario LG9ETK4
crystal white LG9ETK0
romance safari LG9ETK1
passion pulpis LG9ETK2
calacatta shine LG9ETK3
gray stone LG9ET75

BEAK JOLLY velvet
1,3x2cm / 1/2"x3/4"













bianco statuario LG9ETK9
crystal white LG9ETK5
romance safari LG9ETK6
passion pulpis LG9ETK7
calacatta shine LG9ETK8
gray stone LG9ET76

*su richiesta. Per maggiori informazioni circa quantità minime e tempi di consegna rivolgersi all'ufficio commerciale.
upon request. For more information about minimum quantities and delivery times please contact the sales department.
sur demande. Pour plus d'informations sur les quantités minimales et délais de livraison s'il vous plaît contacter le département des ventes.
auf Anfrage. Für weitere Infos über die Mindestmengen und Lieferzeiten wenden Sie sich bitte an unserer Verkaufsabteilung.

DREAMING

gres smaltato a massa colorata GL
colored-body glazed stoneware
grès émaillé a masse colorée
glasiertes Feinsteinzeug mit farbiger masse

spessore 10mm / 11mm
thickness
épaisseur
stärke

CARATTERISTICHE TECNICHE TECHNICAL CHARACTERISTICS CARACTÉRISTIQUES TECHNIQUES TECHNISCHE EIGENSCHAFTEN	metodo di prova test method methode d'essai prüfmethode	valori medi average values valeurs moyens durchschnittliche werte
 assorbimento d'acqua (E) water absorption (E) absorption d'eau (E) wasserabsorption (E)	ISO 10545-3	conforme compliant conforme gemäß
 resistenza al gelo frost resistance résistance au gel frostbeständigkeit	ISO 10545-12	resistente résistant résistant beständig
 resistenza alla flessione bending strength résistance à la flexion beigefestigkeit	ISO 10545-4	≥ 45 N/mm ²
 sforzo di rottura (S) breaking strength (S) chargement de rupture (S) bruchlast (S)	ISO 10545-4	spess. 10mm: ≥ 2'500 N spess. 11mm: ≥ 3'000 N
 resistenza all'abrasione profonda resistance to deep abrasion résistance à l'abrasion profonde widerstand gegen tiefenabrieb	ISO 10545-6	non applicabile not applicable no aplicable nicht anwendbar
 resistenza all'abrasione superficiale resistance to deep abrasion résistance à l'abrasion superficielle oberflächliche reibungsbeständigkeit	ISO 10545-7	pei 4 lux pei 5 velvet
 dilatazione termica lineare thermal expansion dilatation thermique linéaire thermische dilatation	ISO 10545-8	$\alpha \leq 7 \times 10^{-6} \text{ } ^\circ\text{C}^{-1}$
 resistenza agli sbalzi termici thermal shock resistance résistance aux chocs thermiques temperatur wechselbeständigkeit	ISO 10545-9	resistente résistant résistant beständig
 resistenza attacco chimico* chemical resistance résistance chimique chemische beständigkeit	ISO 10545-13	GLA, GHA resistente résistant résistant beständig
 resistenza alle macchie stain resistance résistance aux taches fleckenbeständigkeit	ISO 10545-14	5 (velvet) conforme (lux) compliant conforme gemäß
 coefficient of friction (COF)	ASTM C1028	wet/dry COF ≥ 0.60 (velvet)
 dynamic coefficient of friction (DCOF)	ANSI A 137.1:2012	DCOF ≥ 0.42 (velvet)
 stonalizzazione shading denuançage spießfarbig	ANSI A 137.1	V3

*no acido fluoridrico e derivati
no hydrofluoric acid and its derivatives

FINITURA LUX LUX SURFACE FINISH / FINITION LUX / LUX OBERFLÄCHE

la presenza sporadica di piccole disuniformità o di puntini sulla superficie è da ritenersi come caratteristica del materiale e della particolare lavorazione

the occasional presence of small inconsistencies or of little spots on the surface is to be considered a characteristic of the material and of its particular manufacture

la présence sporadique de petites déformations ou de petits points sur la surface est considérée comme caractéristique du matériau et du traitement spécial

die sporadische Gegenwart von kleinen Unebenheiten oder Pünktchen auf der Oberfläche ist als Merkmal des Materials und der besonderen Fertigungsart zu betrachten

IMPIEGHI USES EMPLOI ANWENDUNGSBEREICHE

FINITURA LUX LUX SURFACE FINISH FINITION LUX LUX OBERFLÄCHE

consigliato per pavimenti in ambienti residenziali
recommended for flooring in residential spaces
recommandé pour les sols dans des espaces résidentiels
empfohlen für Fußböden in Wohnbereichen

FINITURA VELVET VELVET SURFACE FINISH FINITION VELVET VELVET OBERFLÄCHE

consigliato per pavimenti in ambienti residenziali e commerciale leggero
recommended for flooring in residential and low-traffic commercial spaces
recommandé pour les sols dans des espaces résidentiels et commerciaux (petits)
empfohlen für Fußböden in Wohnbereichen und für leichte gewerbliche Nutzung

IMBALLAGGI PACKING EMBALLAGE VERPACKUNGEN

articolo	scatola			europallet				
	pz.	mq	kg	scat.	mq	kg		
fondo	75x75	30"x30"	2	1,13	27,4	42	47,3	1150,8
fondo	73x73	29"x29"	2	1,07	26,3	42	44,8	1105,0
fondo	60x60	24"x24"	4	1,44	32,5	32	46,1	1040,0
fondo	30x60	12"x24"	8	1,44	32,5	32	46,1	1040,0
decoro scraps	60x60	24"x24"	4	1,44	32,5	32	46,1	1040,0
mosaico basic	30x30	12"x12"	4	0,36	8,4	60	21,6	501,0
battiscopa	10x60	4"x24"	12	7,2 m.l.	16,7	60	432,0 m.l.	1002,0
gradino plus	35x60	13 ³ / ₄ "x24"	4	0,84	21,4	16	13,4	342,4
angolo gradino plus	35x35	13 ³ / ₄ "x13 ³ / ₄ "	2	0,25	6,7	36	8,8	241,2
raccordo jolly	1,3x30	1/2"x12"	16	-	1,3	-	-	-
beak jolly	1,3x2	1/2"x3/4"	4	-	0,1	-	-	-

Per una maggiore variabilità grafica della superficie da rivestire, si consiglia di miscelare il prodotto in fase di posa.
Le diverse e numerose facce del prodotto sono imballate secondo una logica randomizzata per garantire la massima variabilità in ogni collo.

For a better graphic variation of the surface, we recommend to mix the product during installation.
The diverse and numerous graphics of the product are randomly packaged to guarantee the best possible variation within each box.

Le rappresentazioni fotografiche e descrittive dei prodotti di Lea Ceramiche riportate sui depliant, sui cataloghi e sugli altri materiali pubblicitari dell'azienda, sono puramente illustrative dello specifico prodotto rappresentato. Si precisa infatti che, successivamente alla pubblicazione dei materiali pubblicitari dell'azienda, il prodotto potrebbe subire leggere modifiche nel relativo processo produttivo, al fine di renderlo tecnologicamente migliore. Tali aggiustamenti tecnologici potrebbero determinare lievi differenze, anche estetiche e/o cromatiche, nel prodotto medesimo, con la conseguenza che lo stesso potrebbe risultare diverso da come rappresentato e/o illustrato e/o descritto nel materiale pubblicitario di Lea Ceramiche. Tali differenze non potranno essere in alcun modo considerate dall'acquirente un vizio e/o difetto del materiale ceramico stesso, bensì una caratteristica dello specifico prodotto. Tutti i materiali ceramici che imitano pietre naturali presentano differenze di colore e sfumature che non potranno in nessun modo essere considerate quale difetto del prodotto, ma bensì una qualità caratteristica di tali tipi di produzione.

The photographs and descriptions of Lea Ceramiche products given in the brochures, catalogues and other corporate advertising materials aim merely to represent the specific products. After the publication of the corporate advertising materials, the products may be slightly modified as a result of technological improvements. Such technological modifications may lead to slight differences in appearance and/or colour of the products, which may therefore differ from the representations, illustrations or descriptions given in the Lea Ceramiche advertising materials. Such differences shall in no way be deemed to be faults and/or defects in the ceramic materials, but rather intrinsic features of the specific products. All ceramic materials that imitate natural stone differ in color and nuances, and this cannot any in way be considered as a product defect, but rather a characteristic of these types of products.



ISO 14001



ISO 9001



emas

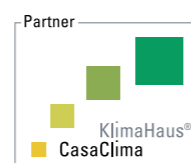

casaclima



leed*



EN 14411

marchio CE****



leed**



Ceramics of Italy

ADIMEMBER

* LEED

Lea Ceramiche, tramite la holding Panariagroup Industrie Ceramiche S.p.A., è socio ordinario del Green Building Council e del GBC Italia. Through Panariagroup Industrie Ceramiche S.p.A., Lea Ceramiche is an ordinary member of the Green Building Council and the GBC Italia. Par le biais de Panariagroup Industrie Ceramiche S.p.A., Lea Ceramiche est membre ordinaire du Green Building Council et du GBC Italia. Lea Ceramiche, durch die Holding Panariagroup Industrie Ceramiche S.p.A., ist ordentliches Mitglied von dem Green Building Council und dem GBC Italien. Lea Ceramiche, a través del holding Panariagroup Industrie Ceramiche S.p.A., es miembro afiliado del Consejo Construcción Verde y del Consejo Construcción Verde de Italia.

** LEED

Il contenuto di materiale riciclato "pre-consumo" della serie Dreaming è del 40%, come certificato da ente esterno qualificato (certificato disponibile sul sito www.ceramichelea.com). Dreaming is produced with 40% of pre-consumer materials, as certified by a qualified external company (certificate available on the website www.ceramichelea.com).

*** CASACLIMA

Lea Ceramiche, tramite la holding Panariagroup Industrie Ceramiche S.p.A., ha ottenuto la certificazione Partner Casaclima. Through Panariagroup Industrie Ceramiche S.p.A., Lea Ceramiche has obtained the Partner Casaclima certification. Par le biais de Panariagroup Industrie Ceramiche S.p.A., Lea Ceramiche a obtenu la certification Partner Casaclima. Lea Ceramiche, durch die Holding Panariagroup Industrie Ceramiche S.p.A., hat die Bescheinigung als Partner Casaclima bekommen. Lea Ceramiche, a través del holding Panariagroup Industrie Ceramiche S.p.A., ha obtenido la certificación Partner Casaclima.

**** MARCHIO CE

Le DOP sono disponibili sul sito internet www.ceramichelea.it
 DOP are available on the website www.ceramichelea.it
 Les DOP sont disponibles sur le site internet www.ceramichelea.it
 Die DOP sind auf Internet Site www.ceramichelea.it verfügbar
 El DOP están disponibles en el sitio web www.ceramichelea.it



DREAMING

ETERNA BELLEZZA
eternal beauty

LEA
CERAMICHE

LEA CERAMICHE
Via Cameazzo, 21
41042 Fiorano Modenese
Modena Italy

Tel +39 0536 837811
Fax +39 0536 830326
info@ceramichelea.it
www.ceramichelea.com

Panariagroup Industrie Ceramiche
S.p.A.

SHOWROOM LEA CERAMICHE
Via Durini, 3
20122 Milano

Tel +39 02 76011406
showroom_milano@ceramichelea.it

LEA NORTH AMERICA, LLC
800 Clanton Road, Suite N
Charlotte, NC 28217

Tel +1 704 522 6300
Fax +1 704 522 6080
info@leausa.us
www.leausa.us